

TOSHIBA



INSTALLATION AND OPERATION MANUAL

TRX-100

SATELLITE RECEIVER



PLEASE READ

	CAUTION RISK OF ELECTRIC SHOCK DO NOT OPEN	
CAUTION: TO REDUCE THE RISK OF ELECTRIC SHOCK, DO NOT REMOVE COVER (OR BACK). NO USER-SERVICEABLE PARTS INSIDE. REFER SERVICING TO QUALIFIED SERVICE PERSONNEL.		



The lightning flash with arrowhead symbol, within a triangle, is intended to alert the user to the presence of uninsulated "dangerous voltage" within the product's enclosure that may be of sufficient magnitude to constitute a risk of electric shock to persons.

The exclamation point within a triangle is intended to alert the user to the presence of important operating and maintenance (servicing) instructions in the literature accompanying the appliance.

WARNING: TO REDUCE THE RISK OF FIRE OR ELECTRIC SHOCK, DO NOT EXPOSE THIS APPLIANCE TO RAIN OR MOISTURE. DANGEROUS HIGH VOLTAGES ARE PRESENT INSIDE THE ENCLOSURE. DO NOT OPEN THE CABINET. REFER SERVICING TO QUALIFIED PERSONNEL ONLY.

CAUTION: TO PREVENT ELECTRIC SHOCK, DO NOT USE THIS POLARIZED PLUG WITH AN EXTENSION CORD OR OTHER OUTLET UNLESS THE BLADES CAN BE FULLY INSERTED.

ATTENTION: POUR PREVENIR LES CHOCs ELECTRIQUES, NE PAS UTILISER CETTE FICHE POLARISEE AVEC UN PROLONGATEUR, UNE PRISE DE COURANT OU UNE AUTRE SORTIE DE COURANT, SAUF SI LES LAMES PEUVENT ETRE INSEREES A FOND SANS EN LAISSER AUCUNE PARTIE A DECOUVERT.

In the spaces provided below, record the Model and Serial No. located at the rear of your satellite receiver.

Model No. _____ Serial No. _____

Retain this information for future reference.

NOTE TO SATELLITE SYSTEM INSTALLER

Please pay close attention to Article 810-20 of the National Electrical Code that provides guidelines for proper installation of antenna discharge units. In particular, this article specifies that each conductor of a "lead in" from an outdoor antenna shall be provided with a listed antenna discharge unit except where the lead in conductors are enclosed in a continuous metallic shield that is effectively grounded.

IMPORTANT SAFEGUARDS

CAUTION

PLEASE READ AND OBSERVE ALL WARNINGS AND INSTRUCTIONS GIVEN IN THIS OWNER'S MANUAL AND THOSE MARKED ON THE PRODUCT.

1. Read the owner's manual carefully, and follow all the operating and safety instructions.
2. All warnings and instructions should be retained for future reference.
3. This product should be operated only from the type of power source indicated on the marking labels. If you are not sure of the type of power supply in your home, consult your sales person or local power company.
4. Power supply cords should be routed so that they are not likely to be walked on or pinched by items placed upon or against them.
5. For added protection against damage to this product due to lightning or powerline surges, unplug power cord from wall outlet and disconnect the antenna or cable system during lightning storms or when left unattended or unused for long periods of time.
6. Do not overload wall outlets and extension cords as this can result in a risk of fire or electrical shock.
7. Never spill liquids on this product or insert objects of any kind through its openings as they may touch dangerous voltage points or short-out parts that could result in a fire or electrical shock.
8. Do not place this product on an unstable cart, stand, tripod, bracket, or table. The product may fall, causing serious injury to a child or adult and serious damage to the appliance.
9. Do not use attachments not recommended by the product manufacturer as they may cause hazard.
10. Slots and openings in the cabinet are provided for ventilation and to ensure reliable operation of the product and to protect it from overheating, these openings must not be blocked by placing the product on a bed, sofa, rug, or other similar surface. This product should never be placed near or over a radiator or heat register. This product should not be placed in a built-in installation such as a bookcase or rack unless proper ventilation is provided.
11. Unplug the product from the wall outlet before cleaning. Use only a soft damp cloth and never use benzene, thinner, or other solvents for cleaning.
12. Before connecting a satellite antenna, conventional TV antenna or cable system to this product, be sure antenna or cable system is properly grounded so as to provide some protection against voltage surges and built-up static charges.

- a. Use No.10AWG (5.3mm) copper, No.8AWG (8.4mm) aluminum, No.17 AWG (1.0mm) copper-clad steel or bronze wire, or larger as a ground wire.
- b. Secure antenna lead-in wire and ground wires to the house with stand-off insulators spaced from 4ft (1.22m) to 6ft (1.83m) apart.
- c. Mount the antenna discharge unit as close as possible to where the lead-in enters the house.
- d. Use jumper wire not smaller than No.6AWG (13.3mm) copper, or the equivalent, when a separate antenna-grounding electrode is used. See NEC section 810-21.

EXAMPLE OF ANTENNA GROUNDING ACCORDING TO NATIONAL ELECTRICAL CODE INSTRUCTIONS CONTAINED IN ARTICLE 810 — "RADIO AND TELEVISION EQUIPMENT"

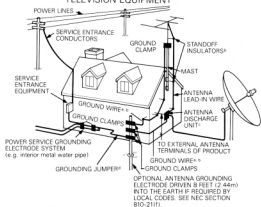

"INSTALL WIRING ACCORDING TO THE CANADIAN ELECTRICAL CODE"
"EFFECTUER LE CABLAGE CONFORMEMENT AU CODE CANADIEN DE L'ELECTRICITE"

13. Unplug the product from the wall outlet and refer servicing to qualified service personnel under the following conditions:
 - a. When the power-supply cord or plug is damaged.
 - b. If liquid has been spilled, or objects have fallen into the product.
 - c. If the product has been exposed to rain or water.
 - d. If the product does not operate normally by following the operating instructions.
 - e. If the product has been dropped or the cabinet has been damaged.
 - f. When the product exhibits a distinct change in performance.

IMPORTANT SAFEGUARDS

14. Upon completion of any service or repair, request the service technicians assurance that only authorized replacement parts have been used and that routine safety checks have been performed to determine that the product is in safe operating condition. Unauthorized parts may result in fire, electrical shock, or other hazards.
15. An outside antenna system should not be located in the vicinity of overhead power lines or other electric lights or power circuits, or where it can fall into power lines or circuits. When installing an outside antenna system, extreme care should be taken to keep from touching power lines or circuits as contact with these lines may be fatal.
16. An appliance and cart combination should be moved with care. Quick stops, excessive force, and uneven surfaces may cause the appliance and cart combination to overturn.

PORTABLE CART WARNING
(Symbol provided by RETAC)



B3125A

FEATURES

Thank you for purchasing the TOSHIBA TRX-100. This system has superior performance and many advanced functions. We are confident that you will be fully satisfied with your new TRX-100.

This system has following features.

Compatible with C/Ku band

The dual LNB inputs may be connected to either single C-band and Ku-band inputs or dual C-band or dual Ku-band inputs.

Built-in VideoCipher® II Descrambler Module

Allows enjoyment of VideoCipher® II programming.

Built-in Programmable antenna positioner

30 C-band satellites and 30 Ku-band satellites can be programmed.

Large Liquid Crystal Multi-Function Display

Displays antenna position, satellite name, channel, audio output level, etc.

On Screen Display

Displays various functions such as memory data, satellite name, channel number on screen.

Favorite Satellite Channel Memory

The TRX-100 can be programming to store your favorite satellite channels. This includes storing the satellite, band, format, channel, and audio tuning.

Additional Features

Sophisticated HIGH-TECH Design

Frequency Synthesized Tuning System

Direct Access To Satellites and Channels

Parental Control (antenna lock, channel lock out)

Beep Sound ON/OFF

Auto Tuning (skew, dish position)

Full Function Remote Control Unit

TABLE OF CONTENTS

IMPORTANT SAFEGUARDS	2
Features & Controls	3
FEATURES	3
INDICATION OF CONTROLS	5
FRONT PANEL.....	5
REAR PANEL.....	5
REMOTE CONTROL	7
LCD (LIQUID CRYSTAL DISPLAY).....	8
Set Up	9
INSTALLATION	9
INITIAL SETUP	13
Basic Operation	17
Advanced Operation	21
FAVORITE PROGRAM	21
PARENTAL CONTROL	23
CHANGING THE SATELLITE PROGRAMS	28
VIDEOCIPHER® II OPERATION	31
SENIOR FUNCTIONS	33
Other	47
TROUBLESHOOTING.....	47
SPECIFICATIONS.....	48
WARRANTY	49

INDICATION OF CONTROLS

FRONT PANEL



① POWER BUTTON

Turns the receiver on or off.

② SATELLITE BUTTON

This button selects the next programmed satellite to the east or west. When the button is released, the dish will automatically begin moving to the requested satellite.

③ CHANNEL BUTTON

Selects channels up or down.

④ LIQUID CRYSTAL DISPLAY

Displays current satellite information.

REAR PANEL

① INPUT C/V

This F connector is one of two "block" inputs accepting signals in the range of 950 to 1450MHz. Selection of this input is determined by the setting of "C/Ku" or "V/H".

② INPUT Ku/H

This F connector is one of two "block" inputs. See 1.

③ 140MHz IF OUT

This F connector is the output from the 2nd converter. It must be connected to 4 via the jumper cable provided. A terrestrial filter may be connected in this loop if necessary.

④ 140MHz IF IN

This F connector is the input to the 140MHz IF strip. See 3.

⑤ INPUT MODE SWITCH

This switch selects the input mode, V, H or C, Ku by the antenna and ODU system which is used.

⑥ RECEIVER MODE SWITCH

This switch selects the receiver mode, AUTO or PROGRAM. This switch should be in the AUTO position except when programming the receiver's memory.

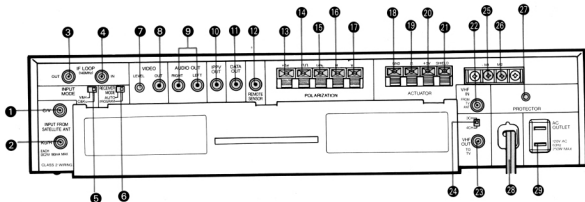

7 VIDEO LEVEL CONTROL

This control adjusts the video output level. This has been properly adjusted at the factory and should only be changed by an authorized technician.

8 VIDEO OUT

This phono connector provides the video output to a VCR or a monitor.

9 AUDIO OUT

These phono connectors provide the audio outputs, left and right, from the receiver. The output level can be adjusted from the remote.

10 IPPV OUT

This phono connector provides output data from the VideoCipher® II module.

11 DATA OUT

This phono connector provides output data from the VideoCipher® II module.

12 REMOTE SENSOR

This jack is used for the optional wired remote control unit.

13 +5V

This terminal is the 5V supply for the polarizer.



This terminal is the output control for the polarizer.

14 GND

This is a return line for 13, 14, 16, 17.

15 H

This is an auxiliary output that provides control signals to the H/V switch when H polarity is selected.

16 V

This is an auxiliary output that provides control signals to the H/V switch when V polarity is selected.

18 GND

An actuator position feedback line used in conjunction with 19 alone or 19 and 20.



This is the return pulse from the actuator.

20 +5V

The actuator signal line that provides +5V to a hall effect device.

21 SHIELD

A shielded line for the actuator signal.

22 VHF IN

A VHF signal input. Connect to a VHF antenna or cable system.

23 VHF OUT

Channel 3 or 4 modulated VHF signal output. Connect to the VHF input on a television set.

24 CHANNEL 3/4

The output of the modulator, 23, (VHF OUT) is controlled by this switch. TV reception on channel 3 or 4 is possible.

25 M1

Combined with 26, this output controls the motor direction and dynamic braking. When the EAST is pressed, +36V appears at the M1 relative to M2.

26 M2

Combined with 25, this output controls the motor direction and dynamic braking. When the WEST is pressed, +36V appears at the M2 relative to M1.

27 PROTECTOR

When pressed, this button resets the circuit breaker for the actuator, and provides power to the actuator.

28 LINE CORD

120V AC, 60Hz (nominal) input.

29 AC OUTLET

Provides 120V AC (250W MAX) as long as the line cord is plugged into an active wall outlet.

INDICATION OF CONTROLS

REMOTE CONTROL

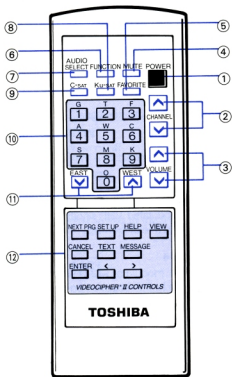

① POWER BUTTON

This button turns the receiver on and off.

② CHANNEL BUTTONS

These buttons allow channel scanning up or down.

③ VOLUME BUTTONS

These buttons adjust the audio volume up or down.

④ MUTE BUTTON

This button mutes the sound. Press again to return to the previous volume level.

⑤ FAVORITE BUTTON

Pressing this button, followed by the ALPHANUMERIC buttons, selects a favorite program channel which can be stored in the receiver's memory.



⑥ FUNCTION BUTTON

Pressing this button, followed by an ALPHANUMERIC button, selects one of the SENIOR FUNCTIONS.



⑦ AUDIO SELECT BUTTON

Pressing this button, followed by the ALPHANUMERIC buttons or EAST  or WEST , selects preprogrammed audio programs.

⑧ Ku-SAT BUTTON

Pressing this button, followed by the ALPHANUMERIC buttons or EAST  or WEST , select Ku-band satellites.

⑨ C-SAT BUTTON

Pressing this button, followed by the ALPHANUMERIC buttons or EAST  or WEST , selects C-band satellites.

⑩ ALPHANUMERIC BUTTONS

These 10 buttons are used to do the following.

- (1) To select a channel and a satellite directly. See page 18.
- (2) To select a favorite program which has been stored in the receiver's memory. See page 22.
- (3) To select an audio program.
- (4) To use senior functions. See page 33.
- (5) To enter passwords.

⑪ ANTENNA EAST/WEST BUTTONS

This button is used to move the antenna. When pressed with ,  or , this button works as  or .

⑫ VIDEOCIPHER® II CONTROLS

These buttons perform those functions associated with the operation of the VideoCipher® II Descrambler, and are operative only when receiving a VideoCipher® signal. See page 31.

Note: ,  and   are also used for other functions.

■ INSTALLING THE BATTERIES

① Press down and pull off.

- ② Insert two AAA batteries, observing the polarity shown by the diagram inside the battery compartment.

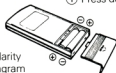

LCD (LIQUID CRYSTAL DISPLAY)

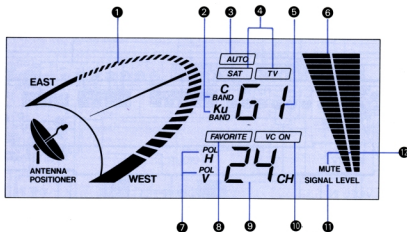
**1 ANTENNA POSITION DISPLAY**

Graphically displays the antenna position.

2 C/Ku BAND INDICATOR

Indicates the satellite band being received.

3 AUTO MODE INDICATOR

Indicates the AUTO mode has been selected on the rear panel.

4 SAT/TV INDICATOR

Indicates "SAT" when the satellite signal is selected to the RF output, and indicates "TV" when the television signal is selected.

5 SATELLITE NAME DISPLAY

Displays the receiving satellite designation by 2 digits. Displays EL when the dish is at the east limit, and WL when the dish is at the west limit.

6 BARGRAPH INDICATOR

When the receiver is in the AUTO mode, the audio output levels are displayed.

When the receiver is in the PROGRAM mode, the input signal strength is displayed.

7 POLARITY INDICATOR

Indicates the channel polarity. Displays "H" for horizontal and "V" for vertical polarity.

8 FAVORITE INDICATOR

Indicates the favorite program is selected.

9 CHANNEL DISPLAY

Displays the receiving satellite channel number or the favorite program number.

10 VIDEOCIPHER INDICATOR

Indicates the system is receiving a VideoCipher® II signal.

11 SIGNAL LEVEL INDICATOR

The input signal level will be displayed when the receiver is in the program mode.

The audio output level will be displayed when the receiver is in the AUTO mode.

12 AUDIO MUTE INDICATOR

Indicates the audio output is muted.

INSTALLATION

1. BASIC INSTALLATION

(1) SINGLE C-BAND

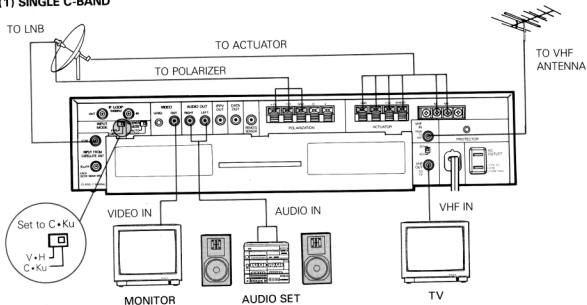

(2) DUAL LNBs

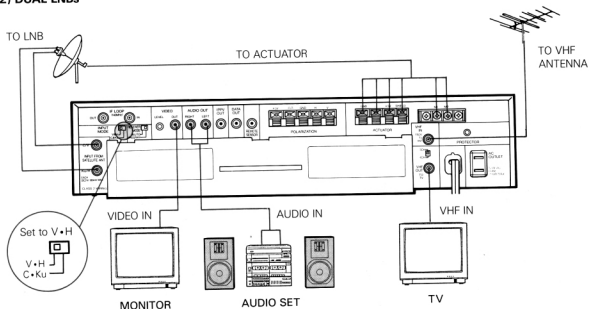

(3) SINGLE C-BAND AND SINGLE Ku-BAND

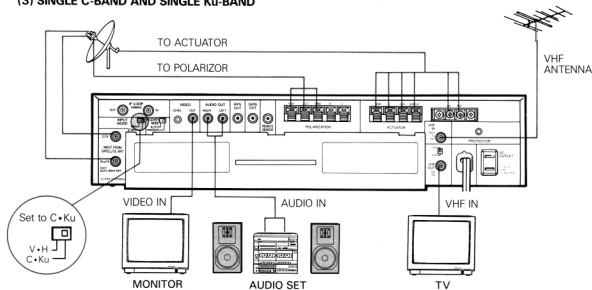

(4) DUAL C-BAND LNBs AND MULTIPLE RECEIVERS

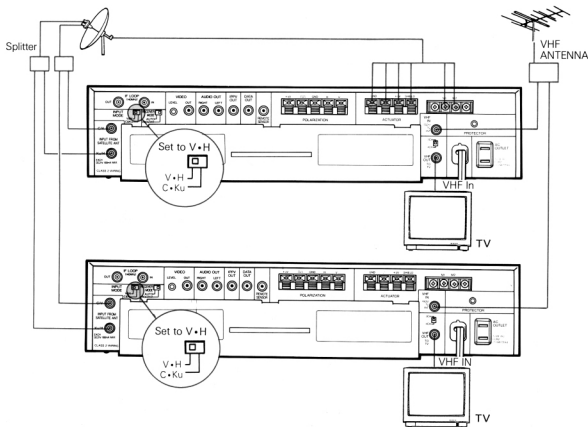

INSTALLATION

2. EXAMPLE OF CONNECTIONS TO OTHER AV COMPONENTS

Ex 1. Connection to a TV, a VCR and an AUDIO SET

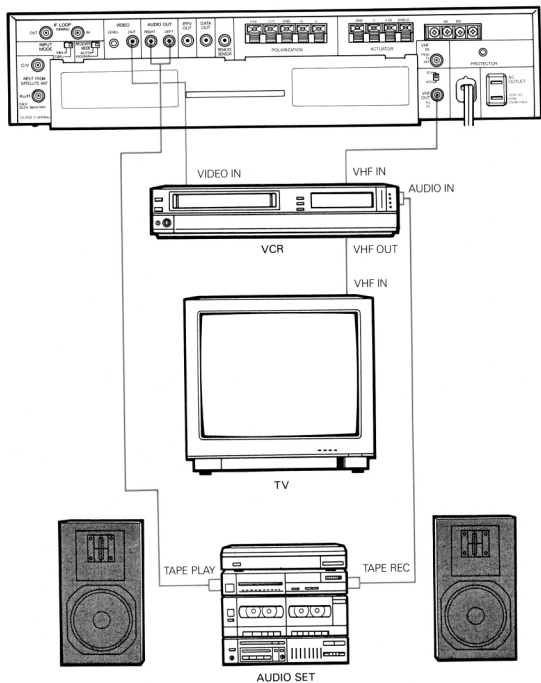

Note: When recording a program on a VCR, set the TRX-100's volume control to 31 (max.).

Ex 2. Connection to a MONITOR, a VCR and an AUDIO SET

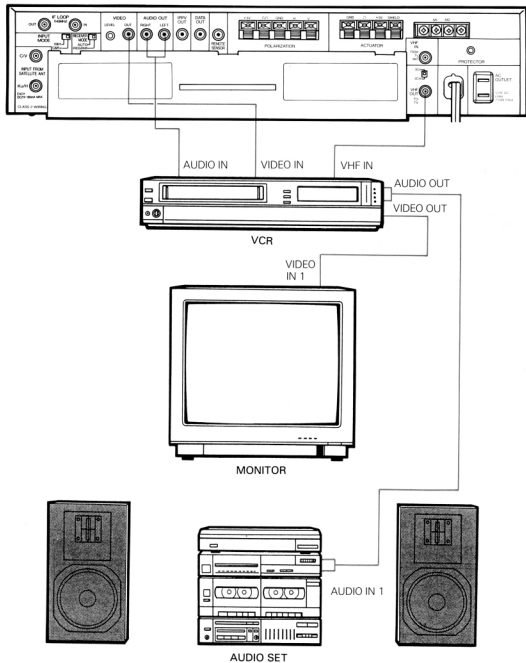

Note: When recording a program on a VCR, set the TRX-100's volume control to 31 (max.).

INITIAL SETUP

The following initial setup procedures must be completed before attempting to operate the receiver. Under normal circumstances, there should be no need to change these programs after this initial setup.

1. SELECTING THE INPUT MODE FOR YOUR SYSTEM

By using the INPUT MODE switch, select the input mode, V & H or C & Ku in accordance with the antenna and LNB System which is being used.



2. POWER ON

Turn on the receiver, the TV, and other equipment (such as an audio system or a video system.) Select the TV channel (3 or 4) in accordance with the receiver's VHF output of TRX-100.

3. SETTING THE RECEIVER MODE

Set the RECEIVER MODE switch on the rear panel to the PROGRAM position.

4. CHECK ACTUATOR WIRING

Confirming that when EAST is pressed, the dish moves to the east. If not, swap connection M1 and M2 on the rear panel of the TRX-100.

5. SETTING ANTENNA LIMITS

Antenna limits must be set to prevent the antenna from traveling too far. Antenna travel limits should be set so the antenna can aim anywhere between the furthest east satellite and furthest west satellite without hitting any objects such as the ground or a fence.

(a) Press **FUNCTION**, **7**, **1** and the display will be as shown at right.

INITIALIZE DATA
ALL DATA

- 1. YES
- 2. NO

SELECT 1-2
THEN (ENTER)

Select and press , at this time all data is initialized as factory preset. The display will be as shown at right.

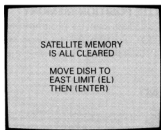

(b) East limit must be set first. Move the dish east until "NO RETURN PULSE" is displayed on screen.

At this time, press WEST for 1 ~ 2 seconds.

This is the electrical east limit.

Press to store this position.

(c) The display will change as shown at right.

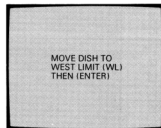

(d) Move the dish to the west until "NO RETURN PULSE" is displayed on screen.

At this time, press EAST for 1 ~ 2 seconds. This is the electrical west limit.

Press to store this position.

Note: To avoid possible damage to an actuator without a mechanical stop, an additional person should be located near the dish to notify the installer the actuator is reaching its limit.

The antenna limit setup is over.

Next, continue to enter the satellite positions.

INITIAL SETUP

5. SATELLITE POSITION MEMORY

Up to 60 satellites can be programmed (C-band: 30, Ku-band: 30). For the 36 satellites listed below, the 2-digit ALPHANUMERIC designates the band, polarity

and audio/video frequencies which have been stored in memory for each of the satellites. Therefore, it is necessary to program only the satellite locations for these 36 satellites.

C-BAND

NO.	DESIGNATION	SATELLITE	POSITION
1	F5	AURORA	143° W
2	F1	SATCOM F1R	139° W
3	G1	GALAXY 1	134° W
4	F3	SATCOM F3	131° W
5	C1	ASC 1	128° W
6	T3	TELESTAR 303	125° W
7	W5	WESTAR 5	122.5° W
8	S1	SPACENET 1	120° W
9	M2	MORELOS 2	116.5° W
10	M1	MORELOS 1	113.5° W
11	A2	ANIK B	109° W
12	A1	ANIK D1	104.5° W
13	W4	WESTAR 4	99° W
14	T1	TELSTAR 301	96° W
15	G3	GALAXY 3	93.5° W
16	W3	WESTAR 3	91° W
17	T2	TELSTAR 302	87° W
18	F4	SATCOM F4	83° W
19	W2	WESTAR 2	79° W
20	O1	COMSTAR D3/D4	76° W
21	G2	GALAXY 2	74° W
22	F2	SATCOM F2R	72° W
23	S2	SPACENET 2	69° W

Ku-BAND

NO.	DESIGNATION	SATELLITE	POSITION
1	T1	SPACENET 1	120° W
2	C3	ANIK C3	117.5° W
3	M1	MORELOS 1	113.5° W
4	C2	ANIK C2	110.0° W
5	G2	GSTAR 2	105.0° W
6	G1	GSTAR 1	103° W
7	S1	SBS 1	99° W
8	S2	SBS 2	97° W
9	S3	SBS 3	95° W
10	S4	SBS 4	91° W
11	K1	SATCOM K1	85° W
12	K2	SATCOM K2	81° W
13	T2	SPACENET 2	69° W

- (a) Press **FUNCTION**, **5**, **1**. The display will be as shown at right.

Select **1** and press **ENTER** to enable the CHANNEL SCAN function.

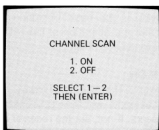

- (b) Press **FUNCTION**, **5**, **2**. The display will be as shown at right.

Select **1** and **ENTER** to enable the AUTO TUNING function.

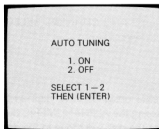

- (c) Select C or Ku-band by pressing **C-SAT** or **KU-SAT** and select a satellite name by pressing **<** or **>** until your desired satellite name appears, or enter the satellite designation (2-digit) by the ALPHANUMERIC buttons.
Ex. When GALAXY 1 is selected.

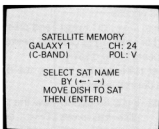

- (d) By pressing and holding **EAST** or **WEST** , move the dish to the selected satellite until a picture is visible. To correctly identify the satellite, please refer to a current programming guide.

Press **ENTER** and the skew automatically adjusts to the satellite and then the antenna position automatically adjusts to the satellite.
When completed, the antenna position is stored.
The display will be as shown at right.

Flashing
during
operation.

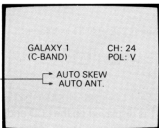

To program additional satellite positions, operate again from (c) to (d).

The INITIAL SETUP is now finished.

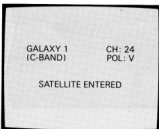

BASIC OPERATION

The following is the basic operation of this receiver assuming that the operation of INSTALLATION section has been properly completed.

1. POWER ON

Press **POWER**. The LIQUID CRYSTAL DISPLAY (LCD) on the front panel will light up. Check the LCD that AUTO appears. If not, set the receiver mode switch on the rear panel to the AUTO position.

2. SATELLITE AND CHANNEL SELECTION



(1) Satellite selection

There are two ways to select a satellite.

● Direct access

Press **C-SAT** or **KU-SAT** and input the desired satellite designation (2 digit as G1, F3, etc.) by pressing the ALPHANUMERIC buttons. Then the dish will move to the desired satellite.

● Next access

Press **C-SAT** or **KU-SAT** and press and hold **EAST**  or **WEST**  until the desired satellite name appears in the display. After releasing the button, the dish will move to the desired satellite.

Note: If it is desired to view the programmed satellite list, press **C-SAT** or **KU-SAT** twice, and it will be displayed on the TV screen.

Press **<** or **>** to see next or previous satellite list.

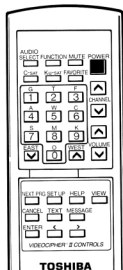



C-BAND SAT, LIST—0
F1 : SATCOM F1R
G1 : GALAXT 1
F3 : SATCOM F3
W5 : WESTAR 5
F2 : SATCOM F2
O2 : OTHER 2

SELECT SAT NAME

Ex. When G1, C-BAND is selected.

Press **C-SAT**, **G**, **1**.
or

Press **C-SAT**, and hold **EAST**  or **WEST**  until G1 is displayed on the LCD and on screen.

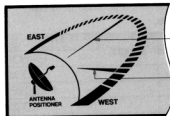

Displays the present antenna position. It moves toward the selected satellite position.

The flashing bar displays the selected satellite position.

GALAXY 1
(C-BAND)

After the dish reach the selected satellite position, (in this case, G1), the display will change.

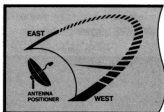
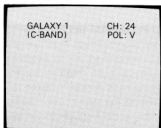

(2) Channel selection

There are two ways to select a channel.

- Direct access

Enter the desired channel number by pressing the ALPHANUMERIC buttons.

- Up, down access

Press CHANNEL or until the desired channel appears.



When a channel is selected, the number will be displayed as shown at right.

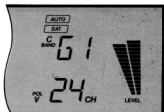
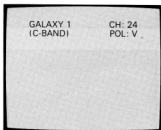

BASIC OPERATION

3. AUDIO PROGRAM SELECTION

The factory programmed satellites are listed on page 15. Audio programs are set by satellite channels. Therefore, there is no need to set the audio frequencies. But when it is desired to listen to a sub audio program, or, when the transmission audio signal has been changed, the audio frequency can be changed. There are two ways to select an audio program.

● Direct access

By pressing **AUDIO SELECT** twice, the AUDIO PROGRAM LIST will appear on screen.

Press **◀** or **▶** to see the next or the previous AUDIO PROGRAM LIST.

Select a favorite audio program number by using the ALPHANUMERIC buttons.

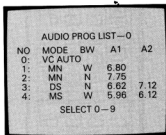

AUDIO PROG LIST—0					
NO	MODE	BW	A1	A2	
0:	VC	AUTO			
1:	MN	W	6.80		
2:	MN	N	7.75		
3:	DS	N	6.62	7.12	
4:	MS	W	5.96	6.12	

SELECT 0—9

● Up, down access

Press **AUDIO SELECT** and hold EAST **⏴** or WEST **⏵** until the desired audio program appears.

When an audio program is selected, it will be displayed on screen.

Note: AUDIO PROGRAM 0 "VC AUTO" is only for VIDEOCIPHER® II channels.

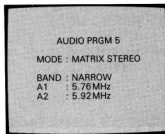

AUDIO PRGM 5	
MODE :	MATRIX STEREO
BAND :	NARROW
A1 :	5.76 MHz
A2 :	5.92 MHz

4. VOLUME CONTROLS AND MUTING

Press VOLUME or button to adjust the audio to a comfortable listening level.

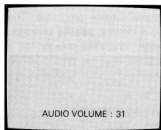

The volume reference level, 0–31 will change by pressing VOLUME or .

The display will be as shown at right.

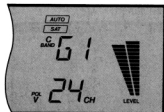

The bargraph indicator will move up or down in accordance to the audio level.

Press to turn off the audio. The display will be as shown at right.

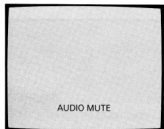

Press again to return to the previous volume level.

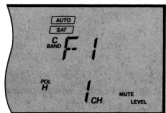

5. MOVING THE DISH

To move the dish, use EAST or WEST .

Note: If the wrong key was pressed or the operation of the TRX-100 was unknown, press , the receiver will return to the normal condition.

If "NO RETURN PULSE" is displayed on screen when a satellite is selected or the dish is moved, check the antenna and actuator connections.

FAVORITE PROGRAM

By using this function, it is possible to store up to 20 of your favorite satellite programs. Then it is possible to select your desired satellite channel without selecting a satellite, channel, polarity, or audio program. These programs may be on the same satellite or 20 different satellites. These features are available in the AUTO mode.

1. FAVORITE PROGRAMING

(1) STORING A FAVORITE PROGRAM

- Confirm that the receiver is in the AUTO mode by checking the LCD on the front panel.
- Receive the satellite, channel and audio that is to be stored.
- Press **FUNCTION**, **4**, **1** and the display will be as shown at right.

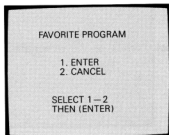

Select **1** and **ENTER**. The receiving satellite channel data will be displayed as shown at right.

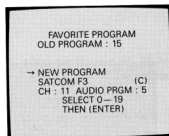

Input the FAVORITE PROGRAM number (0-19), which is to be stored and press **ENTER**

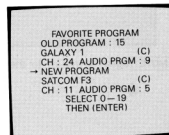

- If it is undecided which program number to store, press **FAVORITE**. Press **<** or **>** to see the next or previous favorite program list. The FAVORITE PROGRAM list will be displayed as shown at right.

Press **VIEW** to return.

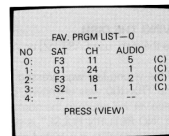

(2) TO CANCEL A FAVORITE PROGRAM

- (a) Confirm that the receiver is in the AUTO mode by checking the LCD on the front panel.
- (b) Press **FUNCTION**, **4**, **1** and the display will be as shown at right.

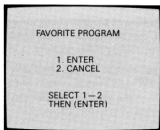

Select **2** and **ENTER**, the display will be as follows.

Press **◀** or **▶** to see the next or previous list.

- (c) Select the program number and press **CANCEL** to delete a program.

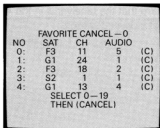

2. OPERATION OF A FAVORITE PROGRAM

Press **FAVORITE** twice and the FAVORITE PROGRAM list will be displayed. Press **◀** or **▶** to see the next or previous list. Enter the program number to select your FAVORITE PROGRAM.

Note: To select a FAVORITE PROGRAM directly without displaying the favorite program list, press **FAVORITE** and continue to enter the desired program number.

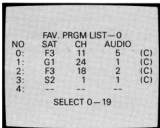

PARENTAL CONTROL

There are two features in PARENTAL CONTROL, one is antenna lock and the other is channel lockout.

The password is needed to use this PARENTAL CONTROL feature.

Initially, 1048 was programmed.

If desired, the password can be changed by using the CHANGING PASSWORD section.

Note: This function can be used only when receiver is in the AUTO mode. When PARENTAL CONTROL is on, the receiver mode can not be changed from AUTO to PROGRAM.

1. ANTENNA LOCK PROGRAMMING

(a) Confirm that the receiver is in the AUTO mode.

Select a desired satellite.

Press **FUNCTION**, **3** and the display will be as shown at right.

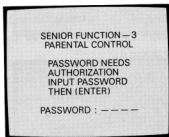

(b) Input the password and press **ENTER**. When the password is correct, the display will be as shown at right.

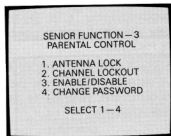

(c) Select 1 and the display will be as shown at right.

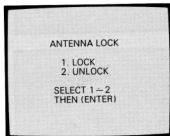

(d) Select lock or unlock

● To lock the antenna, press **1** and **ENTER**.

● To unlock the antenna, press **2** and **ENTER**.

2. CHANNEL LOCKOUT PROGRAMMING

- (a) Confirm that the receiver is in the AUTO mode.

Select the satellite which has the desired channel to be locked out.

- (b) Press **FUNCTION**, **3** and the display will be as shown at right.

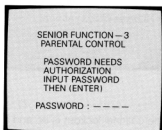

- (c) Input the password and press **ENTER**. When the password is correct, the display will be as shown at right

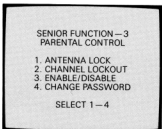

- (d) Select **2** and it will display as shown at right.

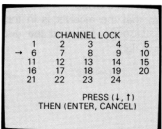

- (e) Program a channel lockout or cancel a channel lockout as follows.

- Programming a channel lockout.

Select the desired channel by pressing **EAST** **▼** or **WEST** **▲**.

Press **ENTER** and the channel is programmed to lockout and an * will be displayed as indicated at right.

Press **VIEW** to return to the normal mode.

- Canceling a channel lockout.

By pressing **EAST** **▼** or **WEST** **▲**, select the channel that is programmed to lock out and is to be viewed.

Press **CANCEL**, the lockout of this channel will be canceled.

Press **VIEW** to return to the normal condition.

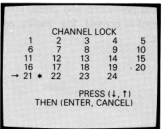

PARENTAL CONTROL

3. OPERATION OF THE PARENTAL CONTROL FEATURES

- When the antenna lock is on and EAST or WEST is pressed to try to move the antenna, or if a satellite ALPHANUMERIC designation is entered, the display will be as shown at right.

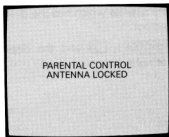

- When the channel lockout is on and a satellite channel is selected that is programmed to lockout, the display will be as shown at right.

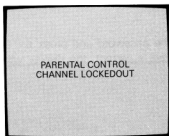

4. TO ENABLE OR DISABLE THE PARENTAL CONTROL FEATURES

- (a) Confirm that the receiver is in the AUTIO mode. Press **FUNCTION** **3** and the display will be as shown at right.

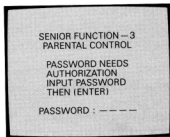

- (b) Input the password and press **ENTER**. When the password is correct, the display will be as shown at right.

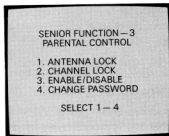

Select **3** and the display will be as shown at right.

(c) Select enable or disable as follows.

- To enable the parental lock:
Select **1** and press **ENTER**.
- To disable the parental lock:
Select **2** and press **ENTER**.

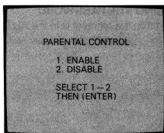

PARENTAL CONTROL

5. CHANGING THE PASSWORD

(a) Confirm that the receiver is in the AUTO mode. Press **FUNCTION**, **3** and the display will be as shown at right.

SENIOR FUNCTION - 3
PARENTAL CONTROL

PASSWORD NEEDS
AUTHORIZATION
INPUT PASSWORD
THEN (ENTER)

PASSWORD : - - - -

(b) Input the password and press **ENTER**. When the password is correct, the display will be as shown at right.

SENIOR FUNCTION - 3
PARENTAL CONTROL

1. ANTENNA LOCK
2. CHANNEL LOCK
3. ENABLE/DISABLE
4. CHANGE PASSWORD

SELECT 1 - 4

(c) Select **4** and the display will be as shown at right.

CHANGE PASSWORD

INPUT NEW PASSWORD
THEN (ENTER)

PASSWORD : - - - -

(d) Input the new password (4 digit) by using the ALPHANUMERIC buttons and press **ENTER** to store.
Ex. When "2486" is entered as new password.

PASSWORD
2486
AUTHORIZED

CHANGING SATELLITE PROGRAMS

(1) STORING ADDITIONAL SATELLITE POSITIONS

- (a) Set the mode switch to the PROGRAM position.
- (b) Press **FUNCTION**, **5**, **1**, **1**, **ENTER** to enable the CHANNEL SCAN function.
- (c) Press **FUNCTION**, **5**, **2**, **1**, **ENTER** to enable the AUTO TUNING function.
- (e) Select C or Ku-band by pressing **C-SAT** or **KU-SAT** and select the satellite by pressing **<** or **>**, or entering the satellite name by using the ALPHANUMERIC buttons.
Ex. When AURORA F5 is selected.

- (f) Press and hold **EAST**  or **WEST**  button, move the dish to the selected satellite until the picture is visible.

- (g) Press **ENTER**, the skew is automatically adjusted to the satellite and then the antenna position is automatically adjusted to the satellite.

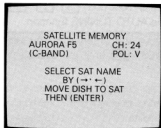

Flashing
during
operation

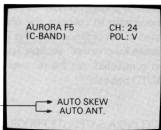

When completed, the antenna position is stored.

When programming is completed, set the receiver mode switch to the AUTO position.

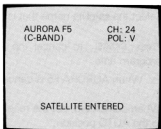

CHANGING SATELLITE PROGRAMS

(2) Programming a Ku-BAND satellite that is not factory programmed.

- (a) Set the receiver to the PROGRAM mode.
- (b) Press **KU-SAT** and enter the satellite ALPHANUMERIC designation. Press **FUNCTION**, **6**, **1** and select the satellite whose channel frequency is like to the channel frequency of the satellite that you want to store. See page 43 in detail.
- (c) Press **FUNCTION**, **5**, **1**, **1**, **ENTER** to set the CHANNEL SCAN function.
- (d) Press **FUNCTION**, **5**, **2**, **1**, **ENTER** to set the AUTO TUNING function.
- (e) Move the antenna by pressing EAST or WEST until the desired satellite picture is visible.
- (f) Press **ENTER**, the antenna skew and the antenna position is automatically adjusted to the satellite.
When completed, the antenna position is stored.

The satellite position is now finished being stored. If it is necessary to calibrate the channel frequency, operated in accordance with the instruction of the "Calibrate Ku-channel" section. (page 43).

When completed, set the receiver mode switch to the AUTO position.

(3) CANCELING A SATELLITE PROGRAM

- (a) Set the receiver mode switch to the PROGRAM position.
- (b) Select the satellite name that is to be canceled.
- (c) Press **CANCEL** to cancel the selected satellite program data.

Ex. When AURORA F5 is canceled.

When completed, set the receiver mode switch to the AUTO position.

KU-SAT FORMAT

1. SBS 1, 2 & 3
 2. SPACENET 1
 3. ANIK C2
 4. ANIK C3
 5. G-STAR
 6. RCA K1 & K2
- SELECT 1-6
THEN (ENTER)

AURORA F5
(C-BAND)

CH : 24
POL : H

SATELLITE CANCELED

(4) TO CLEAR ALL OF THE SATELLITE PROGRAMS

- (a) Set the receiver mode switch to the PROGRAM position.
- (b) Press **FUNCTION**, **7**, **2** and the display will be as shown at right.

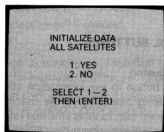

Select **1** and press **ENTER** to initialize all of the satellite program data.

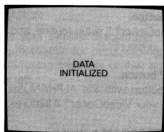

VIDEOCIPHER® II OPERATION

VideoCipher® II programming can be enjoyed by using this receiver. Once authorization has been received, a VideoCipher® II channel can be viewed as an unscrambled channel. VideoCipher® II also has some additional

CONTROL BUTTONS

1. VIEW button

Press this button to see information about the current program being broadcast on the channel. This will include program title, running time and rating.

This button will also return the picture after on-screen display has been viewed.

2. HELP button

If in a VideoCipher® II setup routine, and unsure of what to do next, press HELP.

3. SETUP button

Use this button with the ALPHANUMERIC buttons to customize your VideoCipher® II features.

4. NEXT PROGRAM button

Press this button to see information about the next program.

5. MESSAGE button

Press this button to see the most recently received personal message that has been sent to you from the program supplier.

6. TEXT button

Press this button to see the text information from the program supplier (when being transmitted.).

7. CANCEL button

Press this button to clear incorrect entries for the VideoCipher® II.

8. < > button

These buttons allow VideoCipher® II text services to be moved and rating levels to be changed.

features.

The following features are only available on VideoCipher® II channels.

9. ENTER button

Press this button to confirm selections and password entries for VideoCipher® II channel setup.

OPERATION

1. For Installation

Press **SETUP**, **1** to see your authorization number and signal strength displayed on the screen.

2. Second Language Audio

(1) Press **SETUP**, **2**.

(2) Press **1** to switch between Primary and Alternate.

3. Rating Ceilings

(1) Press **SETUP**, **3**.

(2) Enter your password if one has been set. If no password has been set, proceed to the next step.

(3) Press **<**, **>** to change the rating ceiling.

4. Rating Passwords

Some program suppliers offer a feature that allows you to select the maximum rating of the programs that the unit will descramble.

Any program whose rating exceeds the maximum ceiling you have chosen will be locked out. A rating password can be set to prevent the ceiling from being changed.

To set or change a password.

(1) Press **SETUP**, **4**.

(2) Key in your new password and press **ENTER**.

* If the system already has a password, you will need to key it in before the system accept a new one.

* If you do not want password control, press **ENTER** twice.

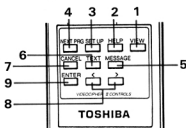

5. Personal Messages

Some program suppliers may choose to send personal messages to you. Typically, these messages will provide additional information about programs, account billings and credits, or special operating instructions.

- (1) A Flashing asterisk (*) will appear on the screen to inform you that a message has been stored.
- (2) To read your message, press **MESSAGE**.
To remove the Message Prompt.
 - (a) Press **SETUP**, **2**.
 - (b) Press **2** to set the prompt ON/OFF.

6. Program Messages

NO SUBSCRIPTION FOR THIS PROGRAM

The system has not been authorized to receive this channel. Contact your program supplier to receive authorization.

BLACK OUT

The desired program is not available in your geographic area.

PROGRAM LOCKED OUT

The program currently being broadcast on that channel exceeds the rating ceiling that has been set.

7. Next Available Program

- (1) Tune to a VideoCipher® II channel.
- (2) Press **NEXT PRG** to see the title rating, the starting time and other information about the next program.
- (3) The other VideoCipher® II service messages may be seen as described above.

8. Text Services

Some program suppliers may offer a text service that may include news Bulletins, programming promotions, and similar broadcast material.

- (1) Tune to a VideoCipher® II channel.
- (2) Press **TEXT**.
- (3) When a page is selected, a three-digit code must be entered (for example, 017 for the 17 page).

Note: VIDEOCIPHER® is a registered trademark of GENERAL INSTRUMENT CORPORATION.

VIDEOCIPHER® trademark is used under license from CABLE/HOME COMMUNICATIONS CORP. (C/HCC), subsidiary of GENERAL INSTRUMENT CORPORATION.

To enable your satellite descrambler and obtain proper authorization for descrambling, appropriate programming providers or their agents must be contacted.

SENIOR FUNCTIONS

This receiver has many advanced functions that are called senior functions.
The senior functions are listed below.

SENIOR FUNCTION LIST

GROUP	FUNCTION	RECEIVER MODE	
		AUTO	PROGRAM
1. CUSTOMER CHOICE	1.1 BEEP ON/OFF	○	○
	1.2 BASIC OSD ON/OFF	○	○
	1.3 LCD BACK LIGHT ON/OFF	○	○
	1.4 ANTENNA MOVE BLANK	○	—
	1.5 CHANNEL SKIP	○	○
	1.6 RF OUTPUT TV/SAT	○	○
2. TUNING	2.1 AUDIO TUNING	○	○
	2.2 CHANNEL FINE	○	○
	2.3 CHANGE POLARITY H/V	○	○
	2.4 ADJUST SKEW	○	○
3. PARENTAL CONTROL	3.1 ANTENNA LOCK ON/OFF	○	—
	3.2 CH LOCKOUT ON/OFF	○	—
	3.3 PL ENABLE/DISABLE	○	—
	3.4 CHANGE PASSWORD	○	○
4. CHANGE PROGRAM	4.1 FAV. PROGRAM ENTER/CANCEL	○	—
	4.2 CHANGE AUDIO PROGRAM	○	○
5. INSTALLATION SETUP	5.1 CHANNEL SCAN ENABLE	—	○
	5.2 AUTO TUNING	—	○
	5.3 SIGNAL BAR SHIFT	—	○
6. INSTALLATION TOOL	6.1 Ku-SATELLITE FORMAT	—	○
	6.2 CALIBRATE Ku-CHANNEL	—	○
	6.3 REALIGN SAT. MEMORY	○	—
	6.4 CHANGE ANTENNA LIMIT	—	○
7. INITIALIZE DATA	7.1 ALL DATA	—	○
	7.2 ALL SATELLITES	—	○
	7.3 Ku-CHANNELS	—	○
	7.4 AUDIO PROGRAMS	—	○
8. DIAGNOSTICS		○	○

○: Indicates the senior function operates in this mode.

—: Indicates the senior function does not operate in this mode.

These functions can be easily used with **FUNCTION** and an ALPHANUMERIC BUTTON as follows.

1. BASIC OPERATION OF THE SENIOR FUNCTIONS

- (a) Press **FUNCTION** and the senior function list will be displayed as shown at right.

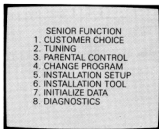

- (b) Select the desired senior function number by pressing an ALPHANUMERIC button.

The senior function which is selected will be displayed as shown at right.

Ex 1. When **FUNCTION**, **1** is pressed.

Menus are displayed for senior functions 2—8, as right for 1.

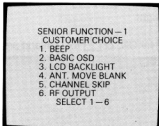

- (c) Select the desired item number by an ALPHANUMERIC button.

Operating instructions will appear on screen.

Ex. 2. When **1** is pressed after Ex. 1.

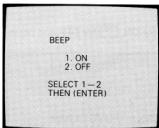

SENIOR FUNCTIONS

2. SENIOR FUNCTIONS

1. CUSTOMER CHOICE

1.1 BEEP ON/OFF

This function is used to set the BEEP sound ON or OFF.
Press **FUNCTION**, **1**, **1** and the display will be as shown at right.

Select **1** for ON, **2** for OFF and press **ENTER** to store.

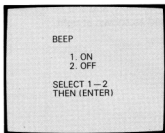

1.2 BASIC OSD ON/OFF

This function is used to set the basic on screen display (channel, band and satellite name etc.) ON or OFF.
Press **FUNCTION**, **1**, **2** and the display will be as shown at right.

Select **1** for ON, or **2** for OFF and press **ENTER**.

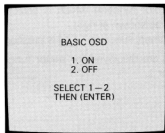

1.3 LCD BACKLIGHT ON/OFF

This function is used to set the backlight of the Liquid Crystal Display ON or OFF.
Press **FUNCTION**, **1**, **3** and the display will be as shown at right.

Press **1** for ON, **2** for OFF and press **ENTER**.

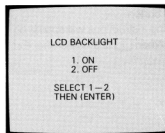

1.4 ANTENNA MOVE BLANK

This function makes the TV screen blackout when the antenna is moving between satellites.
Press **FUNCTION**, **1**, **4** and the display will be as shown at right.

Press **1** for ON, **2** for OFF and press **ENTER** to store.

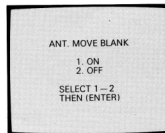

1.5 CHANNEL SKIP

The TRX-100 can be programmed to skip one or more channels of a satellite.

- (a) Select the satellite that has a channel or channels desired to be skipped.
- (b) Press **FUNCTION**, **1**, **5** and the display will be as shown at right.

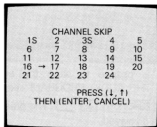

When programming a channel skip:

Select the desired channel by pressing EAST **▼** or WEST **▲**.

Press **ENTER** and the channel is programmed to skip. An * will be displayed as shown at right.

Press **VIEW** to return to the normal condition.

When canceling a channel skip:

Pressing EAST **▼** or WEST **▲** to select the desired channel to cancel a skip.

Press **CANCEL** and the skip will be canceled.

Press **VIEW** to return to the normal condition.

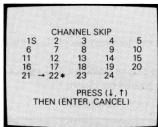
**1.6 RF OUTPUT**

This function is used to select the RF output, TV or satellite.

Press **FUNCTION**, **1**, **6** and the display will be as shown at right.

Select **1** for the TV signal (VHF IN), **2** for the satellite signal and press **ENTER** to store.

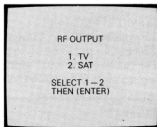

SENIOR FUNCTIONS

2. TUNING

2.1 AUDIO TUNING

Most of the AUDIO PROGRAMS are stored by channel. But when the transmitted audio signal is changed, the audio carrier can be changed.

This function is used to temporarily tune the channel frequency.

When a channel is changed, the preprogrammed audio data will return.

When it is desired to store the audio data, see CHANGE THE AUDIO PROGRAM section (page 40).

(a) Press **FUNCTION** **2** **1**. The present AUDIO data will be displayed.

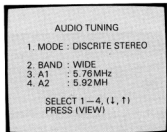

(b) Select the item number (1-4) of the audio tuning.

By pressing or holding EAST or WEST , set to the desired condition.

Press **VIEW** to return.

The items of the AUDIO TUNING are as follows.

● MODE

Select MONAURAL, DISCRETE STEREO or MATRIX STEREO in accordance with the audio mode of the current program.

● BANDWIDTH

Select either NARROW or WIDE audio bandwidth. The bandwidth should be set to produce the best sound. Generally, the WIDE setting is preferred for strong signals and the NARROW setting is better for weak or noisy subcarriers.

● AUDIO "A1"

The audio "A1" is the frequency of the mono, left, or L+R.

Enter the frequency by referring to a current program guide.

● AUDIO "A2"

The audio "A2" is the frequency of the right or the L-R.

Enter the frequency by referring to a current program guide.

2.2 CHANNEL FINE

This function is used to temporarily tune the Ku-satellite channel frequency.

- Select the Ku-band satellite that is to have the channel frequency changed.
- Press **FUNCTION**, **2**, **2**.

By pressing or holding **EAST**  or **WEST**  button, adjust for the best picture.

Press **VIEW** to return to the normal condition.

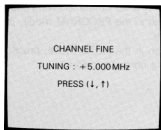

2.3 CHANGE POLARITY

Polarity settings are factory programmed. They are selected when recalling a satellite, and when changing between even and odd numbered channels. If the feed horn is correctly aligned, and if the each satellite is correctly identified, there is no need to change the polarity. When the feed horn is not correctly installed or a new satellite is programmed, which is not in memory, the polarity may be required to be changed by a satellite, or by a channel.

The polarity can be changed as follows.

- Set the receiver mode switch to the desired position. When in the **AUTO** mode, the polarity can be changed temporarily, and the preprogrammed polarity will return when changing satellites. When in the **PROGRAM** mode, the polarity can be changed and stored.

- When receiving a C-band satellite.

Press **FUNCTION**, **2**, **3**, the display will be as shown at right.

Select **1** for the factory programmed polarity, or select **2** for the inverse, and the selected polarity is set on the every channel.

When in the **PROGRAM** mode, press **ENTER** to store.

When in the **AUTO** mode, press **VIEW** to return to the normal condition.

- When receiving a Ku-band satellite.

Press **FUNCTION**, **2**, **4** and the display will be as shown at right.

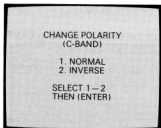

When the receiver is in the **PROGRAM** mode.

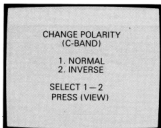

When the receiver is in the **AUTO** mode.

SENIOR FUNCTIONS

Select **[1]** for H, select **[2]** for V, the selected polarity is set on the receiving channel.

When in the PROGRAM mode, press **[ENTER]** to store.

When in the AUTO mode, press **[VIEW]** to return to the normal condition.

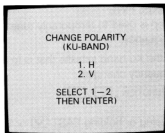

When the receiver is in the PROGRAM mode.

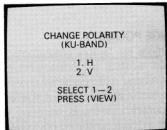

When the receiver is in the AUTO mode.

2.4 ADJUST SKEW

Normally when the AUTO TUNING is selected (SENIOR FUNCTION 5-2), there is no need to adjust the antenna skew. But if desired, the skew can be adjusted manually as follows.

- (a) Press **[FUNCTION]**, **[2]**, **[4]** and the display will be as shown at right.
- (b) Adjust the skew by pressing EAST **[↘]** or WEST **[↙]** to get the best picture.
Press **[ENTER]** to return to normal condition.

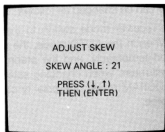

3. PARENTAL CONTROL

This receiver has two parental control functions. They are antenna lock and channel lockout.

See the page 23 to operate.

3.1 ANTENNA LOCK ON/OFF

This function is used to lock the antenna movement.

3.2 CH LOCKOUT ON/OFF

This function is used to lockout a satellite channel.

3.3 PL ENABLE/DISABLE

This function is used to enable or disable the parental control function with the programmed data.

3.4 CHANGING THE PASSWORD

This function is used to change the password that has been programmed for the parental control feature.

4. CHANGE THE PROGRAM

4.1 FAVORITE PROGRAM (ENTER/CANCEL)

The favorite program feature allows up to 20 favorite satellite programs to be stored for automatic recall.

See FAVORITE PROGRAM section (page 21) to operate.

4.2 CHANGE THE AUDIO PROGRAM

Ten audio programs are factory programmed. If desired, the audio program can be changed as follows.

(a) Press **FUNCTION**, **4**, **2** and the display will be as shown at right.

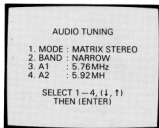

(b) Select the item number (1-4) to tune.

By pressing or holding EAST **↙** or WEST **↘**, set to the desired condition that is to be stored.

Press **ENTER** and the AUDIO program data that is to be stored will be displayed as shown at right.

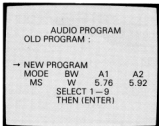

SENIOR FUNCTIONS

Select the AUDIO PROGRAM number (1-9) that is to be stored, and press **ENTER**.

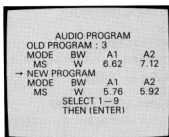

(c) If it is undecided which program number to store, press **AUDIO SELECT**. Then the AUDIO PROGRAM list will be displayed as shown at right.

Press **<** or **>** to see the next or previous list.

Press **VIEW** to return.

Note: AUDIO PROGRAM 0 (VC AUTO) is only for VIDEOCIPHER® II channels. Audio program 0 can not be changed.

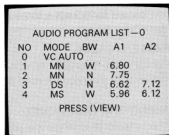

5. INSTALLATION SETUP

The following functions are available only when the receiver is in the PROGRAM mode.

5.1 CHANNEL SCAN ENABLE

The channel scan feature allows the receiver to search rapidly for channels of preprogrammed satellites. The receiver stops scanning when a signal is found. When the channel signal is lost, the receiver begins scanning again.

This function is useful when programming satellites.

See the SATELLITE POSITION section about the advanced operation.

(a) Set the receiver mode switch on the rear panel to the PROGRAM position.

(b) Press **FUNCTION**, **5**, **1** and the display will be as shown at right.

(c) Select **1** for ON or **2** for OFF. Press **ENTER** to turn the channel scan on or off.

When CHANNEL SCAN on is selected, it will begin channel scanning rapidly and will stop when a signal is found.

When the receiver loses the channel signal as EAST **☑** or WEST **☒** is pressed, the receiver begins scanning again.

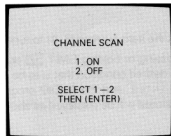

5.2 AUTO TUNING

When this function is on, the antenna position and the skew for the strongest signal is automatically fine-tuned.

- Set the receiver mode switch on the rear panel to the PROGRAM position.
- Press **FUNCTION**, **5**, **2** and the display will be as shown at right.
- Select **1** and press **ENTER** to set the auto tuning.

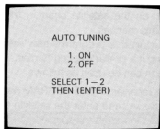

5.3 SIGNAL BAR SHIFT

The signal bar graph indicates the input signal level in the PROGRAM mode, and indicates the audio output level in the AUTO mode. The input signal level can be shifted up or down to accommodate very weak or very strong RF signals.

The signal bar shift has no effect on the audio output level.

- Confirm that the receiver is in the PROGRAM mode.
- Press **FUNCTION**, **5**, **3** and the display will be as shown at right.

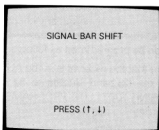

In the PROGRAM mode, the left indicator displays the RF input signal level and the right indicator displays the reference level for the input signal.

If the RF signal is too weak, the reference indicator can be shifted down to compensate for the low input level.

In the AUTO mode, the indicators display the audio output level.

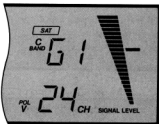

- By pressing or holding EAST **☑** or WEST **☒**, set the indicator to the desired level.
Press **VIEW** to return to the normal mode.

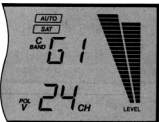

SENIOR FUNCTIONS

6. INSTALLATION TOOL

6.1 SATELLITE FORMAT

This function is used to specify the Ku-band satellite channel format, number of channels, polarity, and center frequencies for any new satellites. This will be helpful when programming a new Ku-band satellite that does not appear on the satellite chart in the programming section of this manual.

The time required to program a new satellite is reduced by assigning it a similar existing format.

This function can be used as follows.

- Set the receiver to the PROGRAM mode.
Press **KU-SAT** and enter the satellite designation that is desired to match the specified the format.
- Press **FUNCTION**, **6**, **1** and select the desired satellite format (1-6).
Press **ENTER** to specify the format.

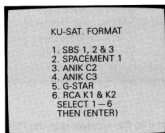

6.2 CALIBRATE Ku-CHANNEL

This function is used to assign any channel frequency to any channel number on the Ku-band. Ku-band satellite channel can be programmed as follows.

- Confirm that the receiver is in the AUTO mode.
Select the Ku-band satellite to be calibrated. See CHANGING SATELLITE PROGRAMS section (page 28) for detailed operation.
- Set the receiver mode switch to the PROGRAM position.
- By using the channel **▼** or **▲** button, or the ALPHANUMERIC buttons, input the channel number to be programmed.
- Press **FUNCTION**, **6**, **2** and the display will be as shown at right.
- By using the EAST **▼** or WEST **▲** button, adjust the frequency for the best picture.
- Press **ENTER** to store the channel frequency.

If it is desired to program additional channels, operate again from (c).

When completed, set the receiver mode switch to the AUTO position.

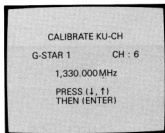

6.3 SATELLITE MEMORY REALIGNMENT

This function is used when a sensor wire has come loose, an actuator clamp has slipped, or an actuator has been reinstalled after a repair. It allows realignment of the actuator to match the already stored satellite positions without having to reprogram all of the satellite positions.

By this function, memory can be restored if all satellites are mis-positioned either east or west by the same amount.

- Confirm that the receiver is in the AUTO mode.
- Select an active channel on the desired satellite that is programmed.
- Press **FUNCTION**, **6**, **3** and the display will be as shown at right.
- By using **EAST** or **WEST** , move the antenna to the position for the best picture.
Press **ENTER** to realign the satellite memory.

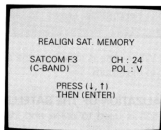

6.4 CHANGE ANTENNA LIMIT

The antenna limits can be changed as follows.

- Confirm that the receiver mode switch on the rear panel is in the PROGRAM position.
- Press **FUNCTION**, **6**, **4** and the display will be as shown at right.
- Select **1** for EAST limit, **2** for WEST limit and press **CANCEL** to cancel old antenna limit data.
Ex. Select **1** for the EAST limit and then **CANCEL**

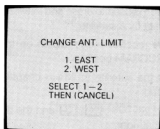

- Move the dish to the new east or west limit which is to be programmed.
Press **ENTER** to store the new antenna limit.

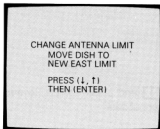

SENIOR FUNCTIONS

7. INITIALIZE DATA

7.1 INITIALIZATION OF ALL DATA

This function is used to erase and initialize all data which has been programmed.

- Set the receiver mode switch on the rear panel to the PROGRAM position.
- Press **FUNCTION**, **7**, **1** and the display will be as shown at right.

Select **1** and press **ENTER** to erase and initialize all data.

Note: When data is initialized, the audio level is set to maximum.

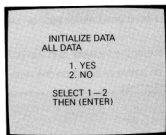

7.2 INITIALIZATION OF THE SATELLITE DATA

This function is used to erase and initialize all of the satellite data.

See the PROGRAMMING SATELLITES section to operate.

7.3 INITIALIZATION OF Ku-CHANNELS DATA

This function is used to erase and initialize Ku-SATELLITE channel data by a satellite.

- Set the receiver mode switch on the rear panel to the PROGRAM position.
- Select the satellite in which channel data is to be initialized.
- Press **FUNCTION**, **7**, **3** and the display will be as shown at right.

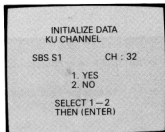

- Input **1** and press **ENTER** to erase and initialize the channel data.

7.4 INITIALIZATION OF AUDIO PROGRAMS

This function is used to erase and initialize the audio program data by satellite, which has been programmed.

- Select the satellite which is to have the audio programs initialized.
- Set the receiver mode switch on the rear panel to the PROGRAM position.
- Press **FUNCTION**, **7**, **4** and the display will be as shown at right.

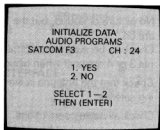

Input **1** and **ENTER** to erase and initialize.

8. DIAGNOSTICS

This function aids in troubleshooting in the event that this receiver should ever develop a problem. By using this function, the service engineer can often help troubleshoot the TRX-100.

Press **FUNCTION**, **8** and the DIAGNOSTICS screen will be displayed.

Press **VIEW** to return to normal condition.

TROUBLESHOOTING

The TRX-100 is designed to give years of trouble free service. However, if a problem should occur, please check the following before calling your dealer.

problem: No picture or sound, no front panel light.

solution: Check that the receiver AC cord is plugged into an active wall outlet.

problem: No picture or sound, but the front panel lights are on.

solution: Check to be sure television is tuned to channel 3 or 4 channel when using the VHF OUT.

Check that the antenna is aimed to an operating satellite.

Check all cable connections.

problem: No picture but sound is OK.

solution: Check cable connections to the video monitor or television.

problem: Snowy or sparkly picture.

solution: Check antenna alignment, polarity fine tuning and all interconnect cables. On some weak transponders, some snow in the picture may be normal.

problem: No sound or noisy sound but the picture is OK.

solution: Check the volume and mute controls.

Check the audio program and the audio tuning.

Check all audio cables for worn insulation or shorts.

problem: Antenna does not return accurately to all satellites.

solution: Check the mounting of the actuator on the antenna, and mounting bolts on the antenna.

Realign satellites by using the REALIGN SATELLITES SECTION in the Senior Functions.

problem: The receiver can not be set to the PROGRAM mode.

solution: Confirm that the PARENTAL CONTROL is off.

problem: The receiver will not enter a SENIOR FUNCTION.

solution: Confirm that the receiver is in the proper mode. Refer to the SENIOR FUNCTION list on page 33.

problem: When the parental control password has been forgotten.

solution: Use the almighty password 1048.

problem: When an unusual condition occurs and function buttons do not operate.

solution: Unplug the AC cord.
Wait a few minutes and reconnect.

SPECIFICATIONS

RF

Input Frequency	950 to 1450 MHz
Input Impedance	75 ohms
Noise Figure	12 dB
Image Rejection	45 dB
Input Signal Level	-60 to -30 dBm
L.O. Leakage at Input Terminal	-50 dBm max.
2nd IF Frequency	140 MHz
Threshold	7 dB C/N
Bandwidth	27 MHz

VIDEO PERFORMANCE

VIDEO OUT

Format	NTSC
Emphasis	CCIR REC. 405-1
Output Impedance	75 ohms
Frequency Response (10KHz to 4.2MHz)	+1/-3 dB
Output Level	1 Vp-p \pm 2 dB

AUDIO PERFORMANCE

Bandwidth	330 KHz/150 KHz changeable
De-emphasis	75 μ sec.
Subcarrier Frequency	5.0 to 8.5 MHz tuneable
Frequency Response	\pm 1 dB (30 to 15 KHz)
Output Impedance	600 ohms Unbalanced
Output Level	-4.2 dBs \pm 2.5 dB at 75 KHz Deviation
Signal to Noise	60 dB

RF MODULATOR

Output Frequency	VHF US 3 or 4ch selectable
Output Level	66 dB μ V \pm 3 dB

POWER

Primary Power	120VAC, 60Hz
Power Consumption	185 watts
Power Supply to LNB	15 to 21.2VDC, 180mA max. \times 2
Polarizer Output (Motor Driven type)	5 \pm 0.5v, 1.0A max.

ACTUATOR INTERFACE

Motor Power (M1, M2)	36V Nominal, 2.5A Max. class 2
5V Supply	Min. 5.5V Max. 6.0V
Sense (Reed Switch) (Hall)	Form C closure +5V TTL Level

ENVIRONMENTAL CONDITIONS

Ambient Operation	+0 to +40°C (32 to 104°F)
Temperature Humidity	Indoor Environment

MECHANICAL

Size	17" \times 3-1/2" \times 13-3/4"
Weight	20 lbs

Design and specifications are subject to change without notice.

LIMITED WARRANTY TOSHIBA SATELLITE RECEIVER

Toshiba America, Inc. ("TAI") makes the following limited warranties. These limited warranties extend to the original consumer purchaser or any person receiving this set as a gift from the original consumer purchaser and to no other purchaser or transferee.

Limited One (1) Year Warranty

TAI warrants this product and its parts against defects in materials or workmanship for a period of one year after the date of original retail purchase. During this period, TAI will repair a defective product or part, without charge to you. You must deliver the entire set to a selling dealer. You pay for all transportation and insurance charges for the set to and from the selling dealer.

Owner's Manual and Warranty Registration

You should read the owner's manual thoroughly before operating this product. You should also insure that your name and address is on file as an owner of a TAI product by completing and mailing the enclosed registration card within ten days after you, or the person who has given you this product as a gift, purchased this product. This is one way to enable TAI to establish the date of purchase of the product, as well as to provide you with better customer service and improved products. Failure to return the card will not affect your rights under this warranty so long as you retain other proof of purchase such as a bill of sale.

Your Responsibility

The above warranties are subject to the following conditions:

- (1) You must retain your bill of sale or provide other proof of purchase. Completing and mailing in the attached registration card within ten days after the original retail purchase is one way of providing such other proof of purchase.
- (2) You must notify the selling dealer within ten (10) days after you discover a defective product or part.
- (3) All warranty servicing of this product must be made by TAI Service Center.
- (4) These warranties are effective only if the product is purchased and operated in the U.S.A.
- (5) Any charges for installation, assembly, set up and adjustment of controls are not covered by this warranty. Reception problems caused by inadequate antenna systems and other components are your responsibility.
- (6) Warranties extend only to defects in materials or workmanship as limited above and do not extend to any product or parts which have been lost or discarded by you or to damage to products or parts caused by misuse, accident, improper installation, improper maintenance, assembly or use with incompatible products or use in violation of instructions furnished by us; or to units which have been altered or modified without authorization of TAI or to damage to products or parts thereof which have had the serial number removed, altered, defaced or rendered illegible.
NOTE: The VideoCipher® II descrambler module should not be returned for service without the TRX-100, unless you have received prior authorization from the TAI Service Center.
- (7) TAI shall have no liability or responsibility to reimburse or compensate you for the loss of paid subscription television programming, such as, but not limited to, HBO, Showtime, etc. in the event this product requires servicing. You are advised to notify each programmer being paid a subscription fee that the product is "out of service" and that you wish to suspend your subscription while the product is being serviced.

Step-by-Step Procedures—How to Obtain Warranty Service

To obtain warranty servicing, you should:

- (1) Contact the selling dealer for warranty service within ten (10) days after you find a defective product or part for instructions.
- (2) Arrange for the delivery of the product to the selling dealer. Products shipped to the selling dealer must be insured and safely and securely packed, preferably in the original shipping carton, and a letter explaining the defect and also a copy of the bill of sale or other proof of purchase must be enclosed. All transportation and insurance charges must be prepaid by you.
- (3) If you have any question about service, please contact the following TAI Service Center:

Toshiba America, Inc.
Service Center
1010 Johnson Drive
Buffalo Grove, IL 60089-6900
Phone Number:
(312) 541-9400

ALL WARRANTIES IMPLIED BY STATE LAW, INCLUDING THE IMPLIED WARRANTIES OF MERCHANTABILITY AND FITNESS FOR A PARTICULAR PURPOSE, ARE EXPRESSLY LIMITED TO THE DURATION OF THE LIMITED WARRANTIES SET FORTH ABOVE. Some states do not allow limitations on how long an implied warranty lasts, so the above limitation may not apply to you. **WITH THE EXCEPTION OF ANY WARRANTIES IMPLIED BY STATE LAW AS HEREBY LIMITED, THE FOREGOING EXPRESS WARRANTY IS EXCLUSIVE AND IN LIEU OF ALL OTHER WARRANTIES, GUARANTEES, AGREEMENTS AND SIMILAR OBLIGATIONS OF MANUFACTURER OR SELLER WITH RESPECT TO THE REPAIR OR REPLACEMENT OF ANY PRODUCT OR PARTS.**

IN NO EVENT SHALL TAI BE LIABLE FOR CONSEQUENTIAL OR INCIDENTAL DAMAGES. Some states do not allow the exclusion or limitation of incidental or consequential damages so the above limitation may not apply to you.

No person, agent, distributor, dealer, service station or company is authorized to change, modify or extend the terms of these warranties in any manner whatsoever. The time within which an action must be commenced to enforce any obligation of TAI arising under this warranty or under any statute, or law of the United States or any state thereof, is hereby limited to one year from the date you discover or should have discovered the defect. This limitation does not apply to implied warranties arising under state law. Some states do not permit limitation of the time within which you may bring an action beyond the limits provided by state law so the above provision may not apply to you. This warranty gives you specific legal rights and you may also have other rights which vary from state to state.

TOSHIBA AMERICA, INC.

BRANCH OFFICE/CHICAGO: 1010 JOHNSON DRIVE, BUFFALO GROVE, ILLINOIS 60089-6900 PHONE: (312) 541-9400